



Description **Phat Noise
Digital Media Player
Installation Instructions**

Part Number **000 057 110**

	Description	Application
Fitment	Touareg	04>

Supplier **PhatNoise**

Published date: **Revision 1
07-03-03**

Sections:

Page 1	Installation
Page 7	Set up & Testing
Page 10	Appendix A Template
Page 11	Appendix B Troubleshooting guide
Page 14	Appendix C Quick Reference





Part Number: **000 057 110**
Description: **Digital Media Player**
Supplier: **PhatNoise**

Fitments: **Touareg**

04>

Tools Required for Phat Noise Digital Music Player Installations



**18mm
Wrench**



**Scratch
Awl**



**Socket
Wrench**



**10mm
Wrench**



1/8" Punch



3mm Allen Wrench



4mm Allen Wrench



**#30 Torx
Socket**



**5mm
Allen Socket**



Part Number: **000 057 110**
Description: **Digital Media Player**
Supplier: **PhatNoise**

Fitments: **Touareg**

04>

000 057 110 Phat Noise Digital Media Player Installation Kits

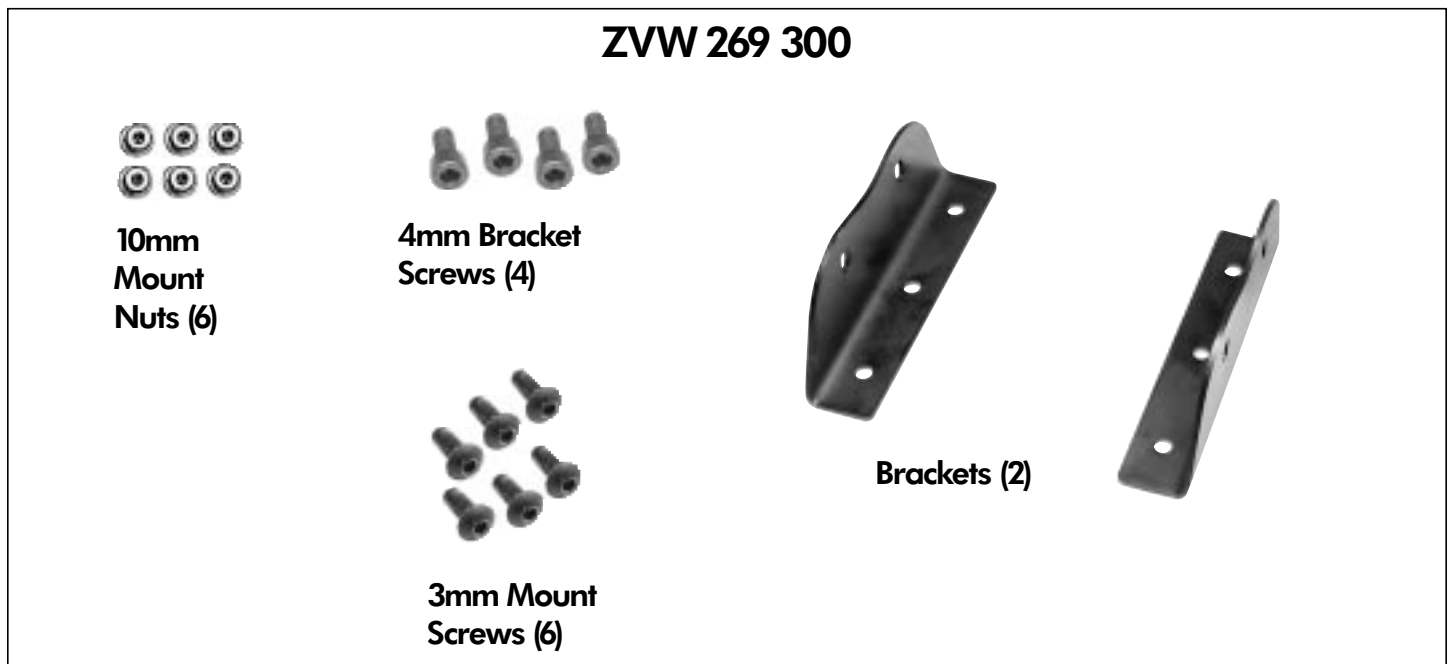
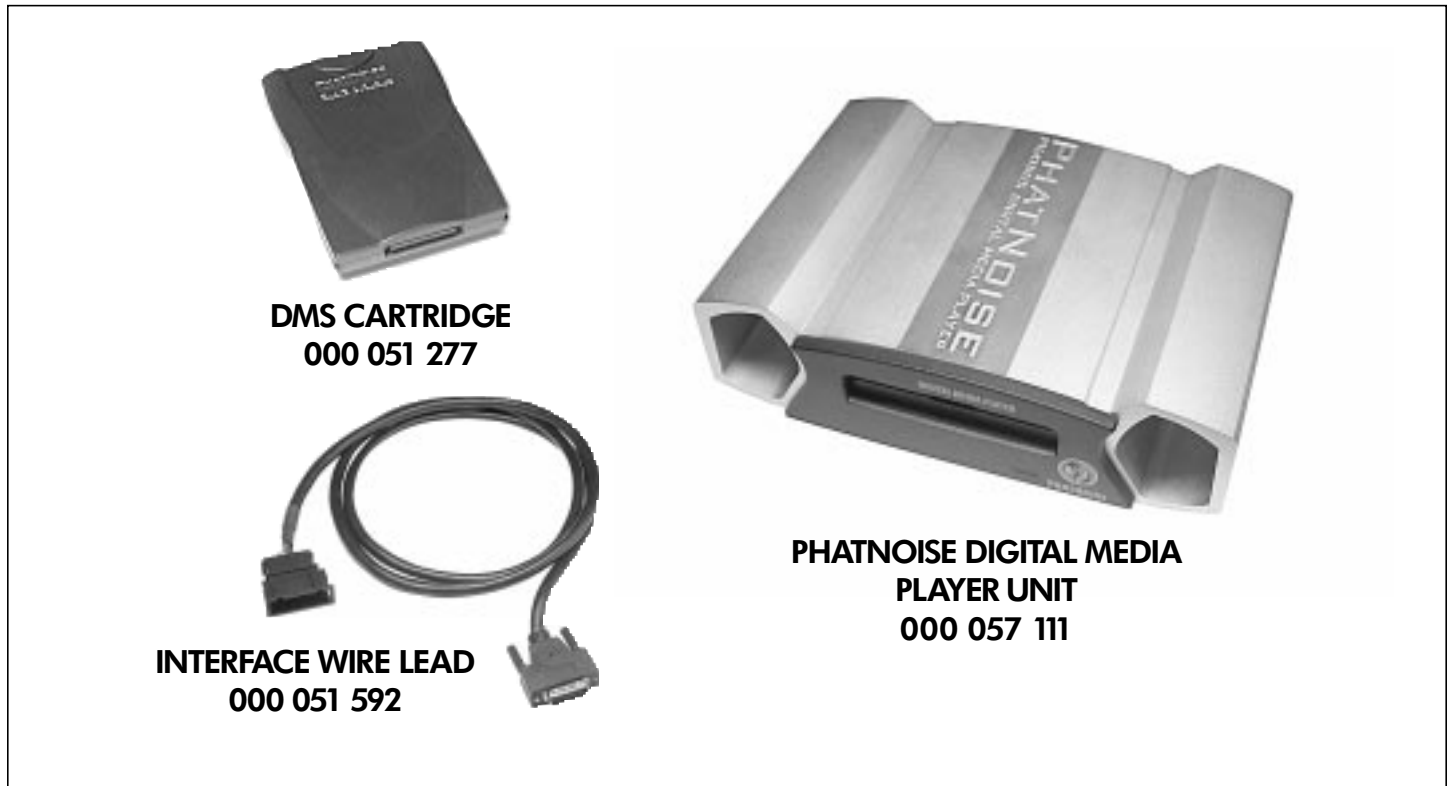



Part Number: **000 057 110**
 Description: **Digital Media Player**
 Supplier: **PhatNoise**

Fitments: **Touareg**

04>

PhatNoise Digital Media Player Installation Kit–Wiring



Step#01

Remove access panel on right side of cargo area and locate CD harness inside.

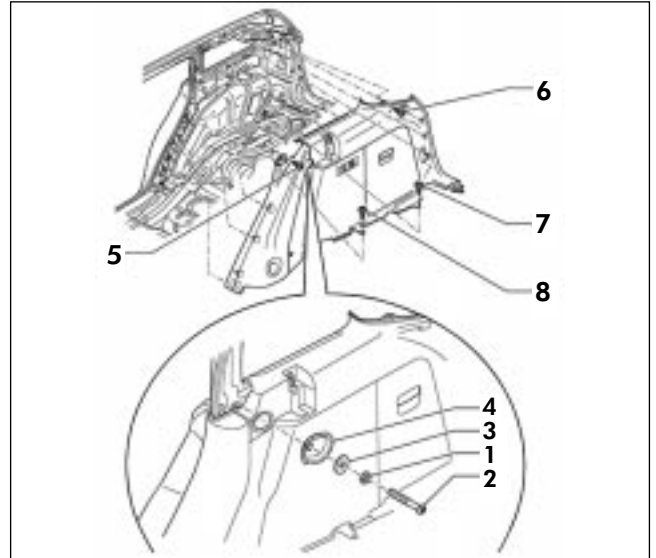

Step#02 (Refer to VESIS Page 70-59)

Remove rear lock cover. Remove luggage compartment floor. Remove lower bolts on side panel to allow enough access to secure nuts behind the bracket.

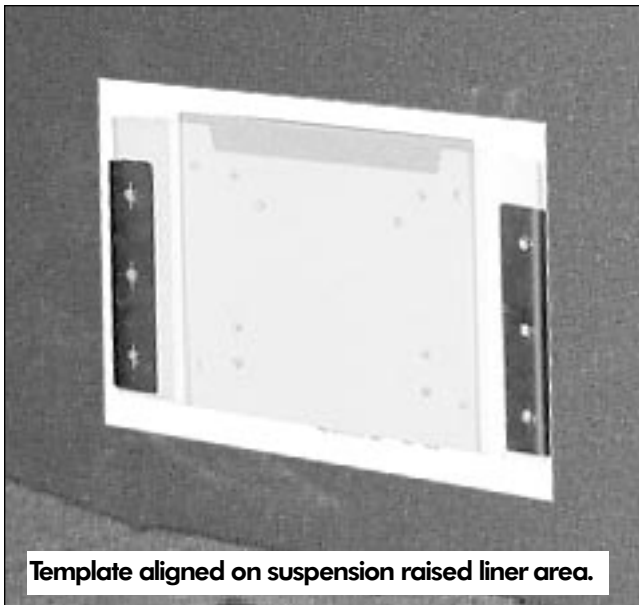

Template aligned on suspension raised liner area.



Template location example on suspension area. (Visualization only).

Step#03

In Appendix A you will find a full sized template for use in locating the holes to attach the PhatNoise brackets. Carefully position the template, aligning the template horizontally and vertically. Attention! See Step #04 for template alignment considerations.



Part Number: **000 057 110**
 Description: **Digital Media Player**
 Supplier: **PhatNoise**

Fitments: **Touareg**

04>

PhatNoise Digital Media Player Installation Kit–Wiring

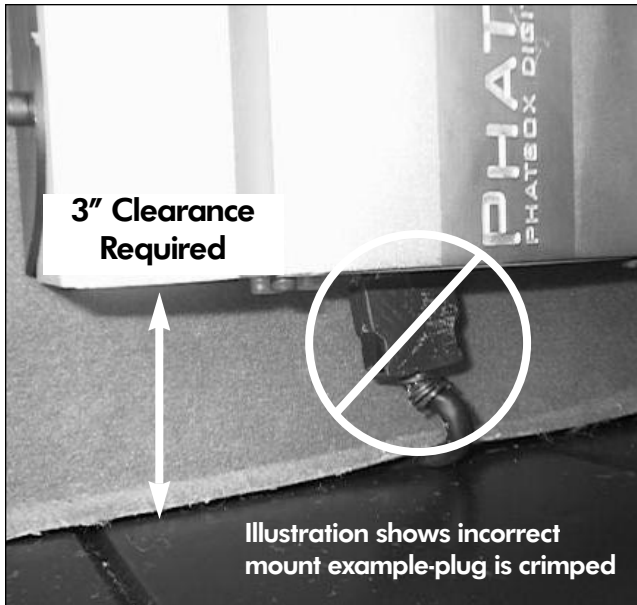

Step#04
 The Template must be positioned to allow 3" clearance for the interface plug.

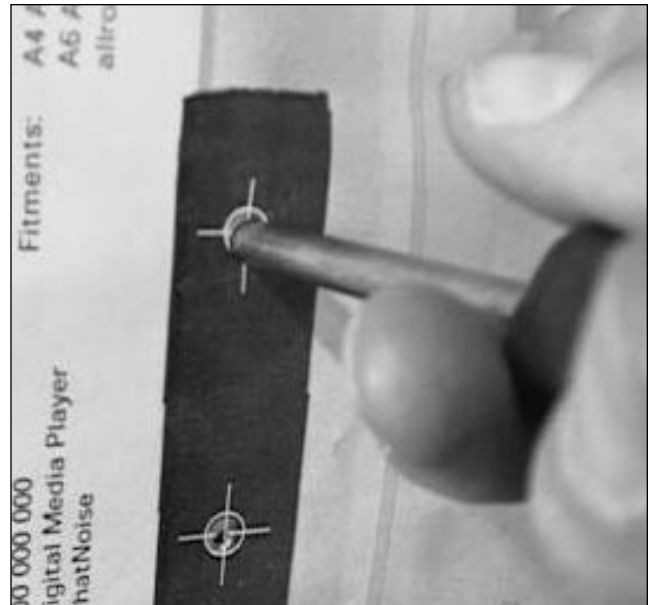

Step#05
 Start pilot hole with template, then punch through with a hole punch. Make sure the holes are not too large.

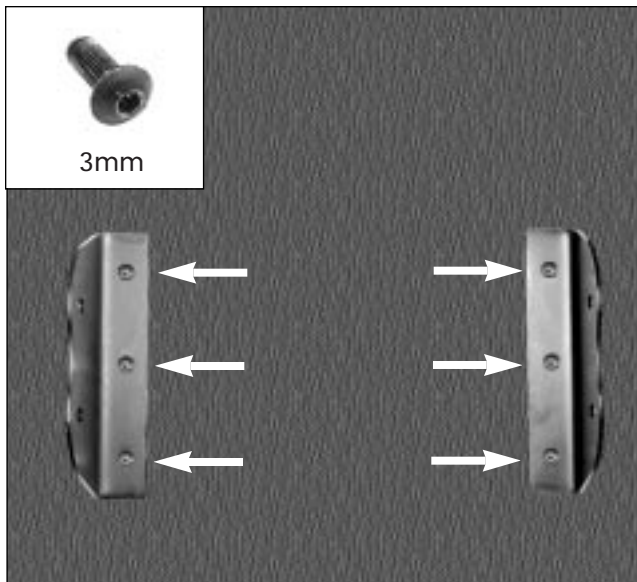

Step#06
 The installation brackets are installed on the right side cargo liner material to the left of the access panel.

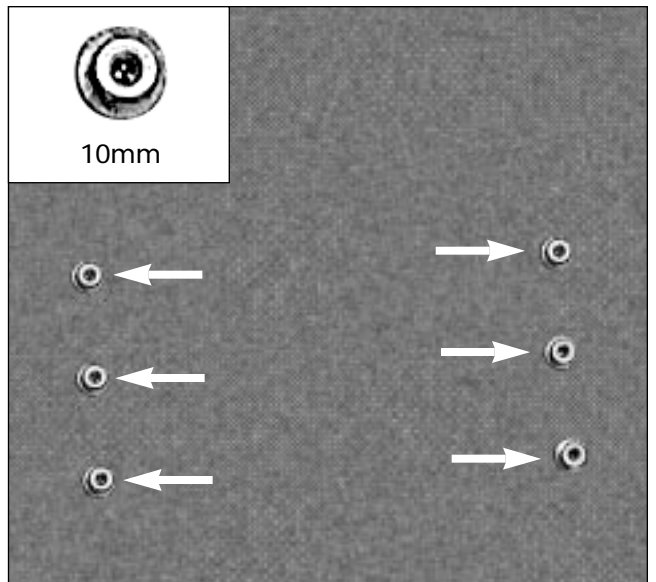

Step#07
 Rear view. Do not torque–material may tear.



Part Number: **000 057 110**
Description: **Digital Media Player**
Supplier: **PhatNoise**

Fitments: **Touareg**

04>

PhatNoise Digital Media Player–Mounting.

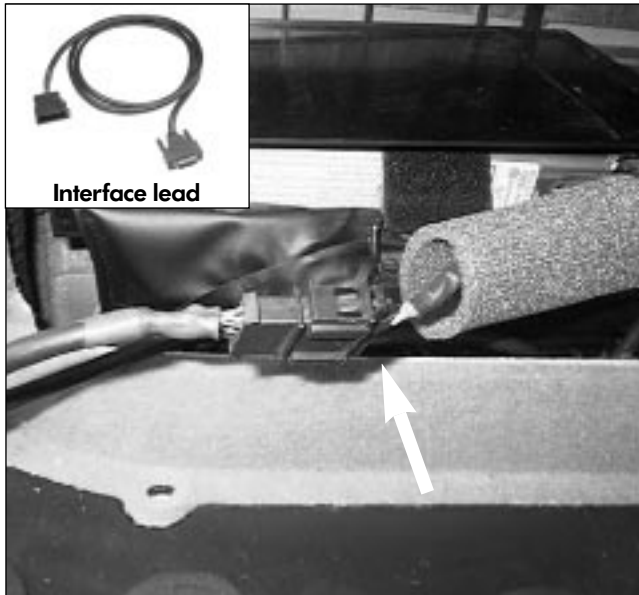

Step#08
Connect the interface wire lead to the adapter.

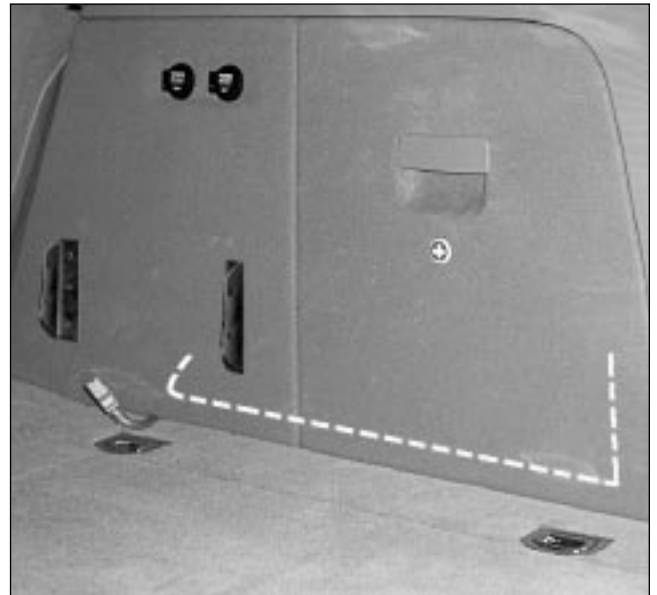

Step#09
Run PhatBox cable behind trim piece and reinstall trim.



Step#10
The DMS Cartridge **MUST** be installed in the unit prior to direct vehicle hook-up. Careful insertion of the DMS Cartridge is essential. The cartridge pin assembly must contact the player electronic feed.



Step#11
Plug interface cable to the back of Phatbox unit and secure with thumb screws. The green and red lights will come on momentarily before going out.



Part Number: **000 057 110**
Description: **Digital Media Player**
Supplier: **PhatNoise**

Fitments: **Touareg**

04>

PhatNoise Digital Media Player–Mounting.

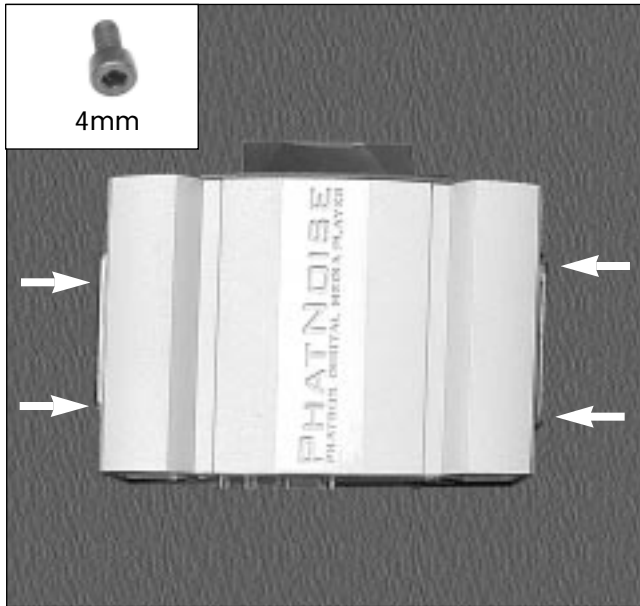

Step#12
Install the four bracket screws.



Completed installation.



Description **Digital Media Player
Installation Instructions–
Set-up and testing**

Part Number **000 057 110**

	Description	Application
Fitment	Touareg	04>

Supplier **PhatNoise™ / Votex GmbH**

Published date: **Revision 1
07-03-03**



Part Number: **000 057 110**
 Description: **Digital Media Player**
 Supplier: **PhatNoise**

Fitments: **Touareg**

04>

PhatNoise Digital Media Player–Set-up and testing.

1. You should see the red and green lights turn on when you connect the interface lead to the CD changer harness.



2. About 5-10 seconds later, both lights should turn off and stay off. DO NOT pull the cartridge out while the lights are blinking.
3. Turn on your car stereo.
4. Switch to CD changer mode on your head unit.
5. Wait for a welcome track to begin playing. You may have to wait up to 15 seconds for the PhatBox to boot.
6. The PhatBox now needs to be configured to a specific Volkswagen stereo model. Turn on your radio, find your stereo model in the table below, and follow the corresponding configuration instructions.

Stereo Model	Configuration instructions
Volkswagen Premium IV stereo Volkswagen Premium IV N.B. stereo	1. Press 6 to go to the feature menu. 2. Press 'track forward' until you get to option 5 in the feature menu.
Volkswagen Premium V stereo Volkswagen Premium V N.B. stereo	3. Press 'scan' at the prompt, "Select Volkswagen cassette only stereo."
Volkswagen Premium VI stereo w/ CD Player	1. Press 6 to go to the feature menu. 2. Press 'track forward' until you get to option 6 in the feature menu. 3. Press 'scan' at the prompt, "Select Volkswagen CD and cassette stereo."

Even when the stereo is off and the key is out of the ignition, the PhatBox will remember the configuration. You will only need to configure the PhatBox again if:

- The firmware is reprogrammed.
 - The PhatBox loses power, e.g. PhatNoise interface cable becomes unplugged, or car battery loses power.
7. Appendix B of this installation guide contains some troubleshooting tips. You may also consult the "Appendix B" in the PhatNoise Owner's Manual for additional troubleshooting information.



Part Number: **000 057 110**
Description: **Digital Media Player**
Supplier: **PhatNoise**

Fitments: **Touareg**

04>

PhatNoise Digital Media Player–Set-up and testing.

Starting the PhatBox

The PhatBox is available through the CD mode of the radio. The unit powers on and off automatically, and resumes where you last left playback.

To begin playback:

1. Insert the DMS cartridge into the cartridge slot of the PhatBox.
2. Turn on the radio and switch to the CD mode. This is labeled CD on the radio.
3. Playback will resume where the system last stopped.

Playback Modes

Mode 1 is "Track Mode": In this mode, the Track up/down buttons move playback to the next/previous track. The possible active playback modes are playlist, album, artist or genre.

Mode 2 is "Playlist Mode": In this mode, the Track up/down buttons move playback to the next/previous playlist. After the desired playlist is chosen, wait 5 seconds and the PhatBox will re-enter Track Mode playing the first track.

Mode 3 is "Album Mode": In this mode, the Track up/down buttons move playback to the next/previous album. The PhatBox will announce the name of the album, and after 5 seconds the PhatBox will re-enter Track Mode playing the first track.

Mode 4 is "Artist Mode": In this mode, the Track up/down buttons move playback to the next/previous artist. The PhatBox will announce the name of the artist, and after 5 seconds the PhatBox will re-enter Track Mode playing the first track.

Mode 5 is "Genre Playback Mode": In this mode, the Track up/down buttons move playback to the next/previous genre. The PhatBox will announce the name of the genre, and after 5 seconds the PhatBox will re-enter Track Mode playing the first track.

Mode 6 is "Features Mode": In the Feature mode you can set special features and options of the PhatBox. The Track up/down buttons change the feature to be selected. To make a selection, press the SCAN or Fast Forward button. A voice will describe the features that can be activated.

Appendix A.—Bracket template.

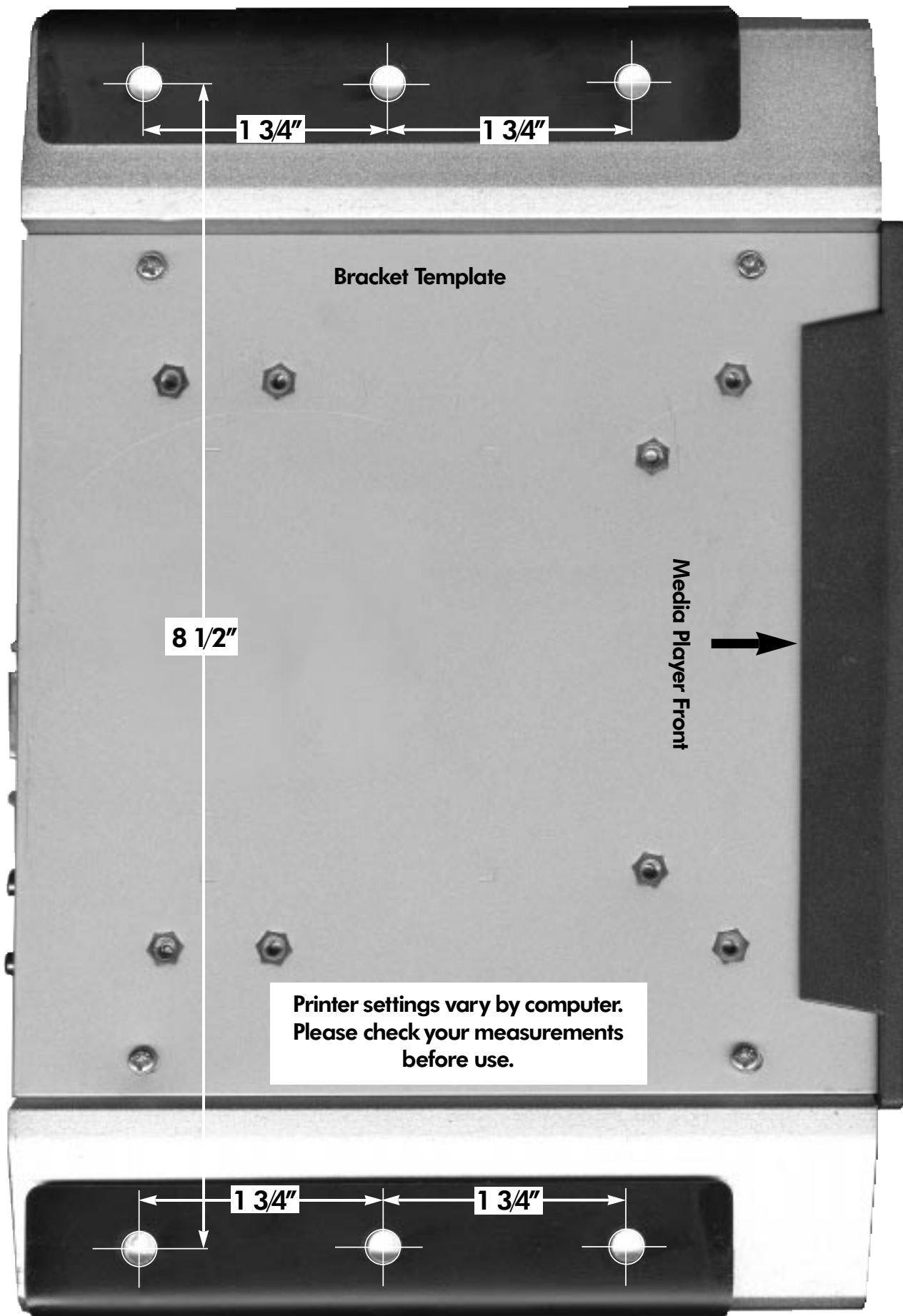



Part Number: **000 057 110**
 Description: **Digital Media Player**
 Supplier: **PhatNoise**

Fitments: **Touareg**

04>

Appendix B–Troubleshooting

Note: Check “Appendix B” in PhatNoise Owner’s Manual for additional troubleshooting information.

When Installing the PhatBox:

Problem	Cause/Solution
No lights come on at all.	<p>The PhatBox connector cable and/or head unit wiring harness is connected incorrectly. Reconnect the PhatBox connector cable and/or head unit wiring harness correctly. Make sure each connection is firmly connected.</p> <p>OR</p> <p>The DMS cartridge is not fully inserted. Fully insert the DMS cartridge.</p> <p>OR</p> <p>A fuse in the car has blown. After checking for short circuits in the wires, replace the fuse with one with the same rating.</p>
The green light blinks for 15 seconds, then turns off, then blinks for 15 seconds, then turns off...this cycle repeats continuously.	<p>The DMS cartridge is not fully inserted. Fully insert the DMS cartridge.</p> <p>Or,</p> <p>File(s) on your cartridge may be corrupt. Run the PhatNoise DMS Doctor on your computer and follow the recommendations.</p>
The green light blinks at a steady rate for longer than 20 seconds.	<p>You have updated the firmware on the DMS cartridge and the PhatBox is reprogramming itself. DO NOT REMOVE THE DMS CARTRIDGE. Allow the PhatBox to reprogram itself for up to 10 minutes. When reprogramming is complete, the lights will turn off and stay off.</p>
<p>Using the PhatBox:</p> <p>The radio displays NO MAGAZINE or CHK MAGAZINE.</p>	<p>The system is still booting. Please wait up to 15 seconds for the system to boot, and switch back to CD mode.</p> <p>Or,</p> <p>The DMS cartridge is not fully inserted. Fully insert the DMS cartridge.</p> <p>Or,</p> <p>File(s) on your cartridge may be corrupt. Run the PhatNoise DMS Doctor on your computer and follow the recommendations.</p>



Part Number: **000 057 110**
 Description: **Digital Media Player**
 Supplier: **PhatNoise**

Fitments: **Touareg**

04>

Appendix B–Troubleshooting

Note: Check “Appendix B” in PhatNoise Owner’s Manual for more troubleshooting information.

General Cases: Problem	Cause/Solution
No Sound.	<ul style="list-style-type: none"> - Adjust the volume of the head unit. - Make sure the PhatBox cable is correctly connected to the head unit. - Make sure the head unit has the CD changer as the active source. - Make sure the navigation or telephone mute is not activated.
The head unit does not recognize the PhatBox.	<ul style="list-style-type: none"> - Make sure the PhatBox cable is correctly connected to the head unit. - Note that during firmware reprogramming (green light flashing), your head unit will NOT recognize the PhatBox - for this reason, it is often better to have the head unit off during programming.
No Sound. The head unit cannot access the PhatBox. Green light on PhatBox blinks and does not stop blinking.	<p>File(s) on your cartridge may be corrupt. Run the PhatNoise DMS Doctor on your computer and follow the recommendations.</p> <p>If you have just downloaded new firmware, this is normal. Wait about 7 minutes until the green light stops blinking, then both lights should go off.</p>
Audio skipping occurs during playback.	<p>Many things can cause a 'skip', or any break in audio playback.</p> <p>If you are hearing breaks in playback, here are some things to check:</p> <ol style="list-style-type: none"> 1. When you hear a skip, restart the track (or seek backwards a bit) to hear if the skip is actually in the music file. 2. Note that on some SSA radios, when the playback mode changes a brief mute in sound may occur. This is normal and a property of the radio. 3. Check to see if you are using the latest firmware and desktop software. This is very important, as software is updated frequently. 4. Sometimes a heavily fragmented cartridge can skip due to increased seek times. Defragment the cartridge for best performance.



Part Number: **000 057 110**
 Description: **Digital Media Player**
 Supplier: **PhatNoise**

Fitments: **Touareg**

04>

Appendix B–Troubleshooting

Note: Check “Appendix B” in PhatNoise Owner’s Manual for additional troubleshooting information.

Problem	Cause/Solution
WMA files are not playing in the PhatBox	Some software such as Windows Media Player features copy protection in their WMA encoding tools. This prevents the tracks from playing on any device other than your computer. Disable any "Copy protect music" checkbox when encoding music (consult your software's manual for more information).
PhatNoise Music Manager software errors containing a "Codebase" message. Or The PhatNoise Music Manager playlists are missing or not working properly.	The PhatNoise Music Manager database files have been corrupted. To fix the database: -Close the PhatNoise Music Manager software. -Run the Database Doctor in the PhatNoise Music Manager folder on the Start Menu. If this does not fix the problem, delete the folder "Data" in the PhatNoise Music Manager installation directory (usually C:\Program Files\PhatNoise Music Manager). Please note that this will erase the entire user's database and playlist files. All the songs will need to be reloaded and the playlists will need to be redefined.
When transferring files to the DMS a message appears "Long File names not supported"	The DMS has been mounted incorrectly, or improperly formatted. Cancel the current copy operation, eject the cartridge, close the PhatNoise Music Manager, restart the PhatNoise Music Manager, and try the operation again.
When a DMS cartridge is inserted into the USB cradle, neither the green nor the red light turn on. Or	The external AC/DC power adapter is not connected. Make sure the connection is firmly connected. The DMS cartridge is not inserted all the way. Apply gentle pressure with your hand to the top of the DMS cartridge to see if this makes the lights come on. If the lights go off right away after you remove your hand, the lever switch inside the USB cradle may be out of alignment.
USB cradle is not recognized properly.	- Make sure the computer is running Windows 98, Windows ME, Windows 2000, or Windows XP. WinNT 4.0 and Windows 95 do not have proper USB support. - The USB interface has been disabled in the system settings or in the motherboard BIOS.
Voice prompts are missing in the car	Check your voice prompt settings: 1. Insert the DMS. 2. Open the Device view and select the DMS. 3. Press the Hardware Options button. 4. Open the DMS Database Voice Prompts tab and click Fix Voice Prompts.



Part Number: **000 057 110**
 Description: **Digital Media Player**
 Supplier: **PhatNoise**

Fitmments: **Touareg**

04>

Appendix C—PhatBox user’s quick reference

